

# VTLG4

H 225 mm  
D 380 mm  
L 970 mm

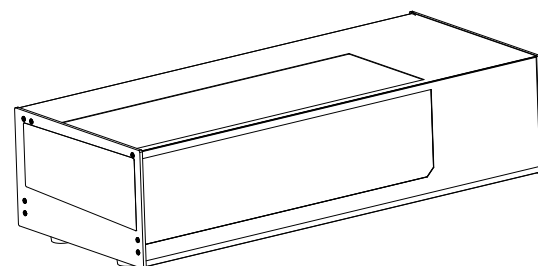

## 3D



## GENERAL SIZES

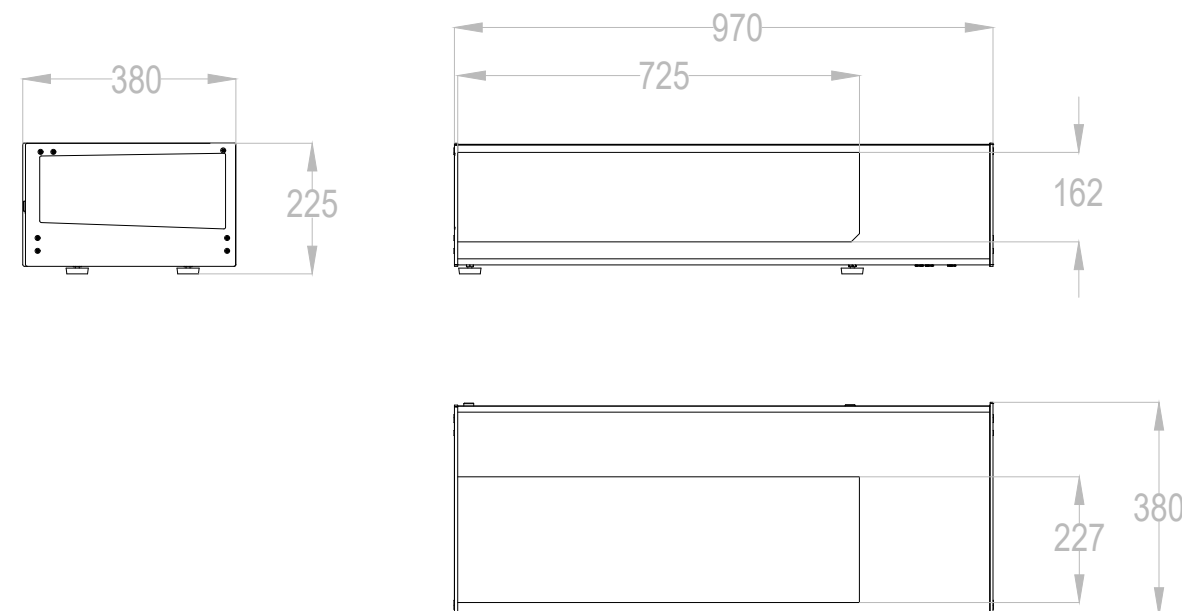

## TECHNICAL DATA

**Installation**  
Plug-in

**Temperature**  
+2 / +6°C

**Refrigerant**  
R600A

**Refrigeration**  
Ventilated

**Compressor**  
HXD55

**Defrost**  
Automatic

**Climate class**  
3

**Glass type**  
Single glass

**Opening system**  
Rear sliding double door

**Lighting**  
Double LED 4000K

**Configuration**  
-Mechanical control panel

**External dimensions (LxDxH)**  
970 x 380 x 225 mm

**Capacity (gross/net)**  
44,6 / 6 L

**Weight**  
35 KG

**Energy class**  
B

**Energy efficiency index**  
16,3

**Annual energy consumption**  
867,24 kWh/A

**Operating conditions**  
25°C / 60% RH

**Frigorific input**  
170W

**Electrical input**  
85W

**Power supply**  
230V / 50Hz

**Openings (Rear/Front)**  
Yes / No

## GOOD PRACTICES

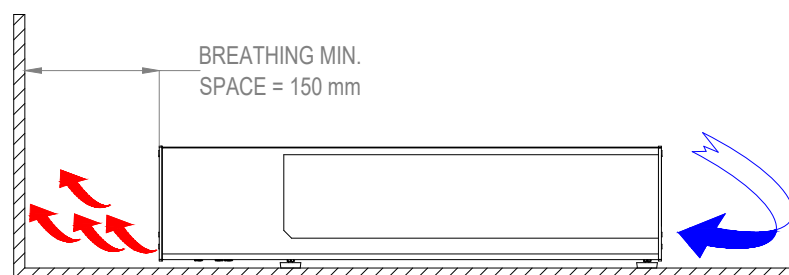

## ELECTRIC DIAGRAM

